

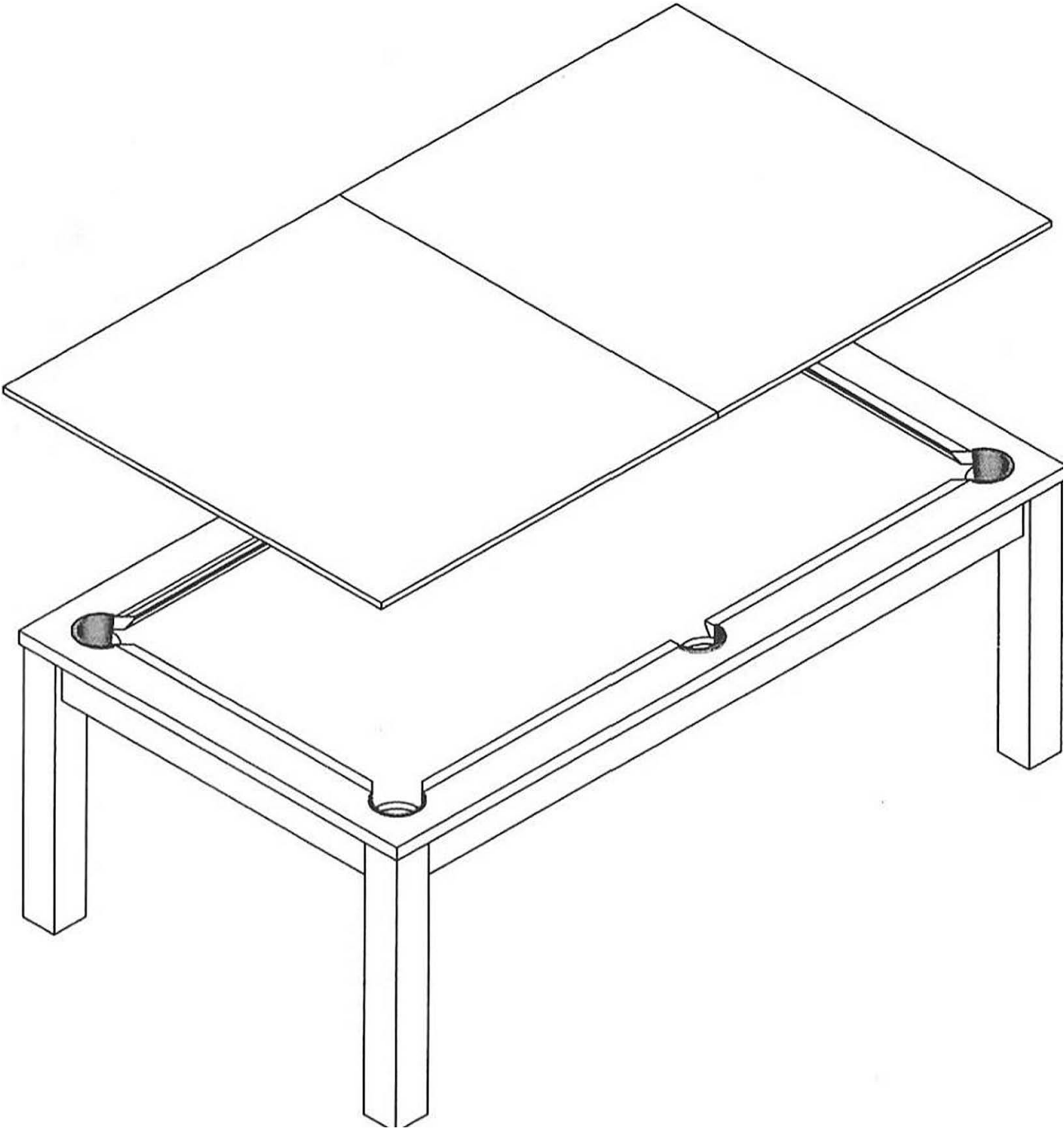











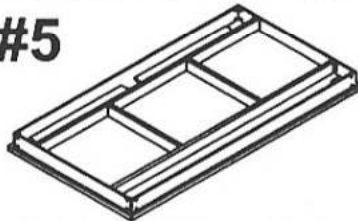
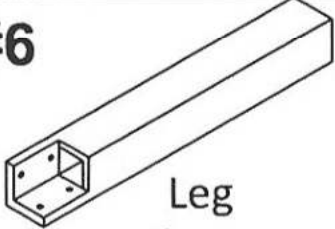
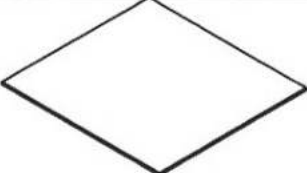

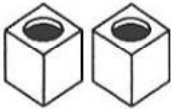
MOD. 7FT 2-EN-1

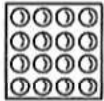
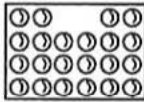
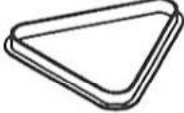

PARTS IDENTIFIER

<p>#1</p>  <p>5/16" Bolt 16 pcs</p>	<p>#2</p>  <p>5/16" Washer 16 pcs</p>	<p>#3</p>  <p>Leg leveler 4pcs</p>
<p>#4</p>  <p>Tool 1 pc</p>	<p>#5</p>  <p>Billiard table 1set</p>	<p>#6</p>  <p>Leg 4 pcs</p>
<p>#7</p>  <p>Dining table 2pcs</p>	<p>#8</p>  <p>Shaker 1pc</p>	<p>#9</p>  <p>Dice 1set</p>
<p>#10</p>  <p>Chalk 2 pcs</p>	<p>#11</p>  <p>Brush 1 pc</p>	<p>#12</p>  <p>Wood plug 2 pcs</p>
<p>#13</p>  <p>Cue stick 4pcs</p>	<p>#14</p>  <p>Cross bar 1pc</p>	<p>#15</p>  <p>Crown bar 1pc</p>
<p>#16</p>  <p>2-1/4" Billiard ball 1set</p>	<p>#17</p>  <p>2-1/16" Billiard ball 1set</p>	<p>#18</p>  <p>2-1/4" Triangle rack 1 pc</p>

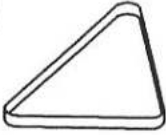
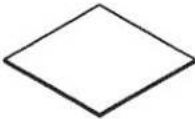
PARTS IDENTIFIER

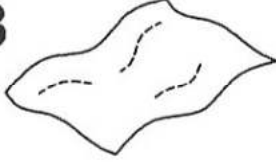
#19  2-1/16" Triangle rack 1 pc	#20  Gasket 2 pcs	#21  Scoreboard 1 pc
#22  Wooden cue holder 1 set	#23  Table cover 1 set	

ASSEMBLY INSTRUCTIONS

WARNING: TWO ADULTS NEEDED ASSEMBLE POOL TABLE

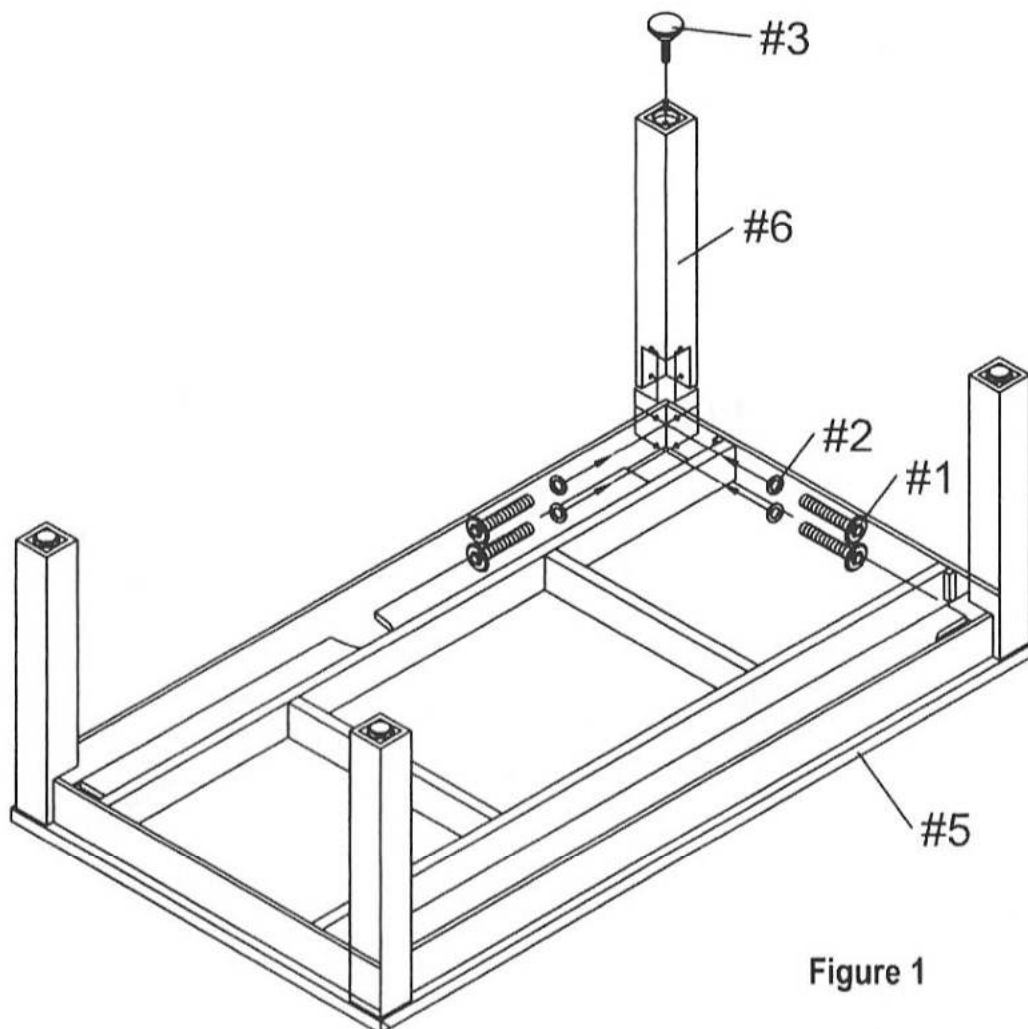

Figure 1

ASSEMBLY INSTRUCTIONS

WARNING: TWO ADULTS NEEDED ASSEMBLE POOL TABLE

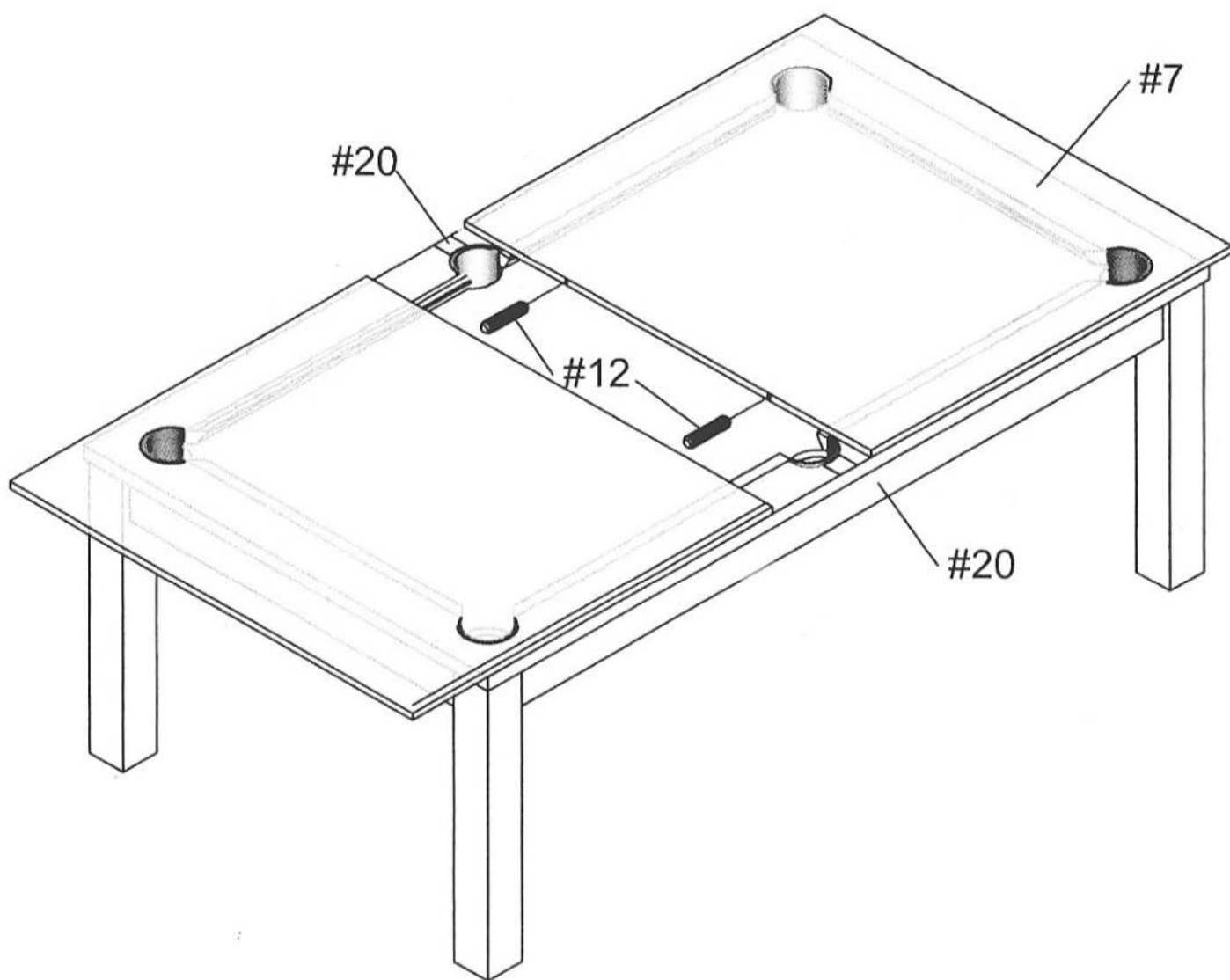

Figure 2